

Kreuzriss
(A. v. rechts)

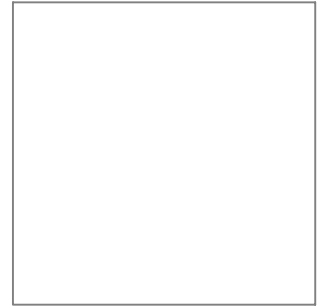

Aufriss

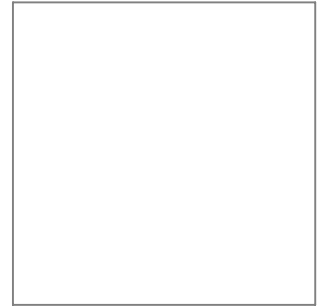

Grundriss

Schnitt mit Ebene $z = 1$

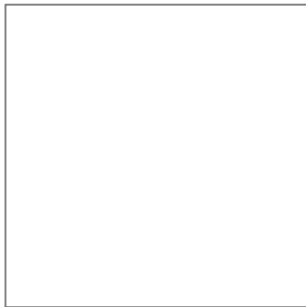

Grundriss

Schnitt mit Ebene $z = 2$

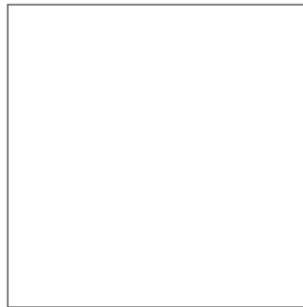

Grundriss

Schnitt mit Ebene $z = 3$

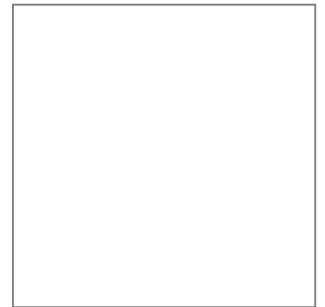

Grundriss

Schnitt mit Ebene $x = 1$



Aufriss

Schnitt mit Ebene $x = 2$

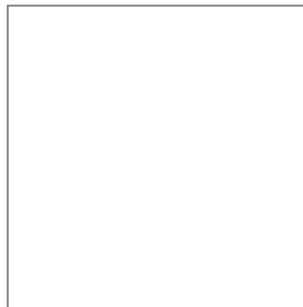

Aufriss

Schnitt mit Ebene $x = 3$

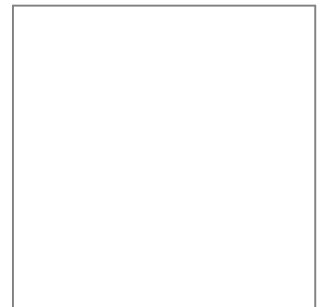

Aufriss

Schnitt mit Ebene $y = 1$

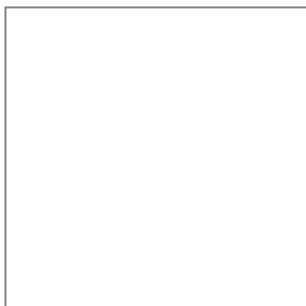

Kreuzriss
(A. v. rechts)

Schnitt mit Ebene $y = 2$

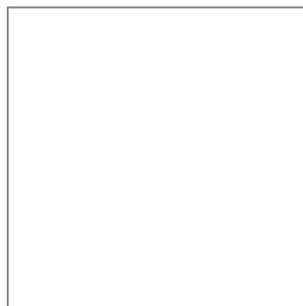

Kreuzriss
(A. v. rechts)

Schnitt mit Ebene $y = 3$

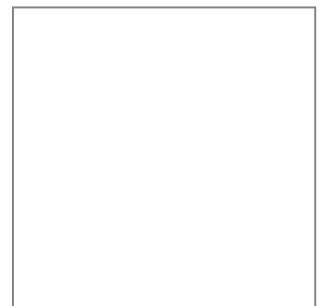

Kreuzriss
(A. v. rechts)

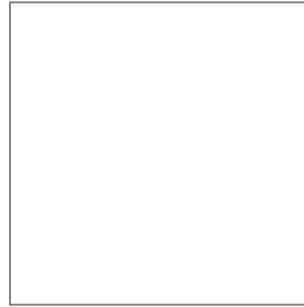
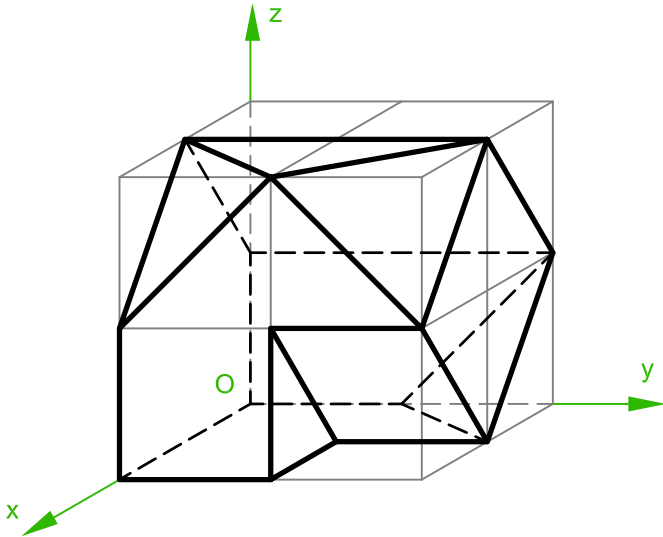

Kreuzriss
(A. v. rechts)

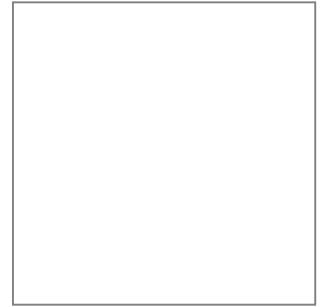

Aufriss

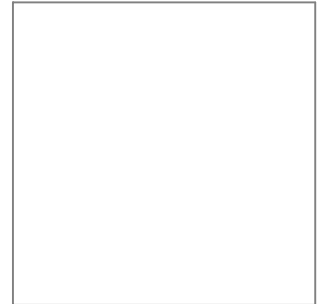

Grundriss

Schnitt mit Ebene $z = 1$



Grundriss

Schnitt mit Ebene $z = 2$

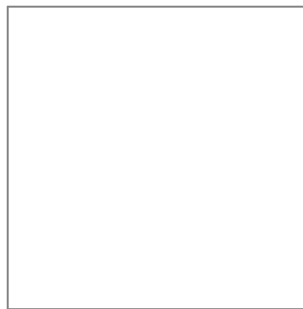

Grundriss

Schnitt mit Ebene $z = 3$

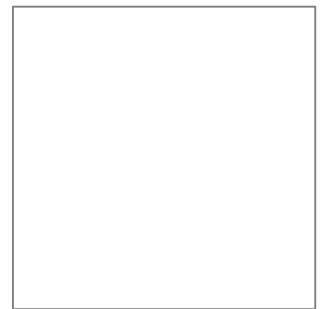

Grundriss

Schnitt mit Ebene $x = 1$

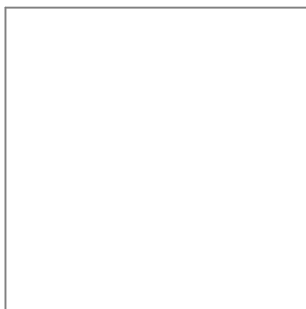

Aufriss

Schnitt mit Ebene $x = 2$

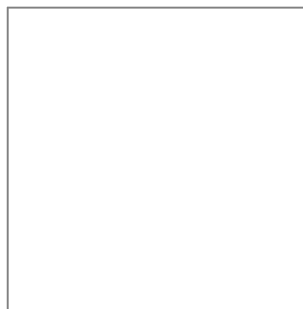

Aufriss

Schnitt mit Ebene $x = 3$

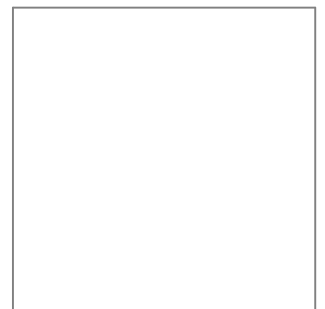

Aufriss

Schnitt mit Ebene $y = 1$

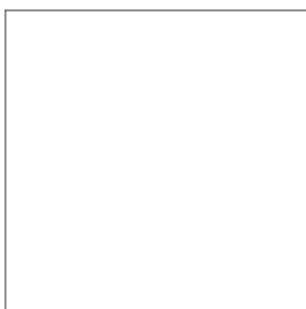

Kreuzriss
(A. v. rechts)

Schnitt mit Ebene $y = 2$

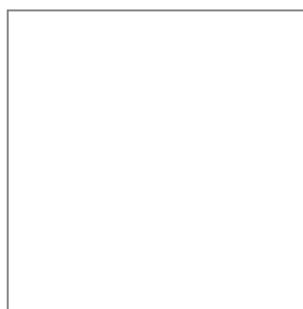

Kreuzriss
(A. v. rechts)

Schnitt mit Ebene $y = 3$

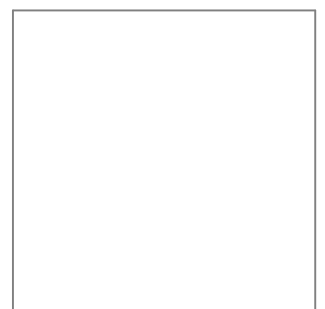

Kreuzriss
(A. v. rechts)

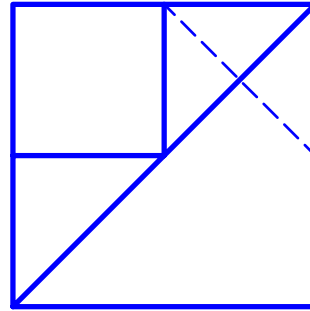
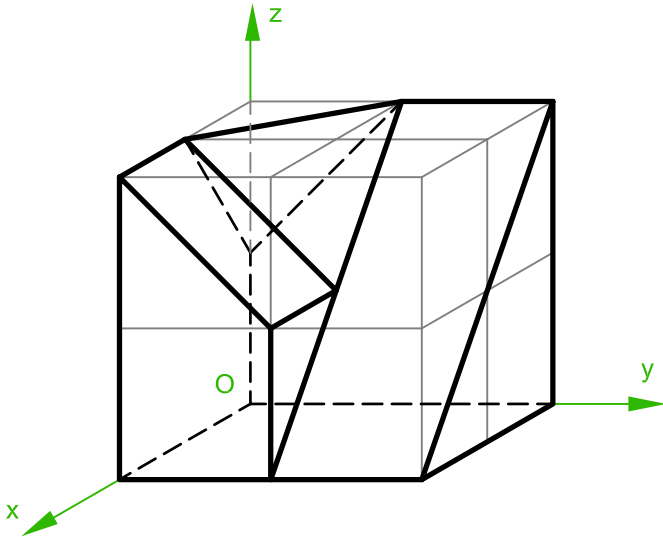

Kreuzriss
(A. v. rechts)

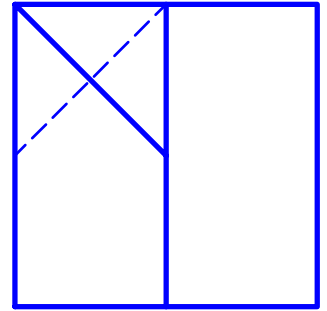

Aufriss

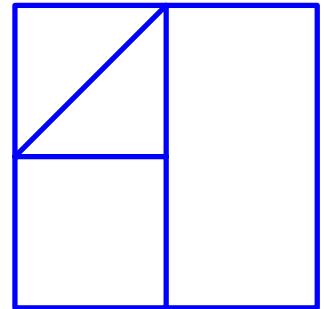

Grundriss

Schnitt mit Ebene $z = 1$

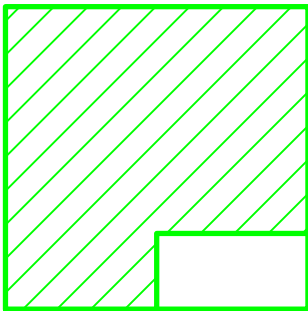

Grundriss

Schnitt mit Ebene $z = 2$

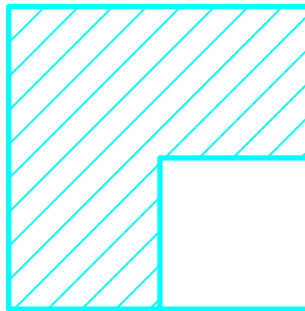

Grundriss

Schnitt mit Ebene $z = 3$



Grundriss

Schnitt mit Ebene $x = 1$

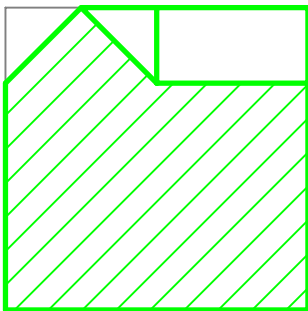

Aufriss

Schnitt mit Ebene $x = 2$

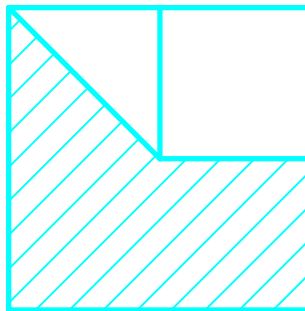

Aufriss

Schnitt mit Ebene $x = 3$

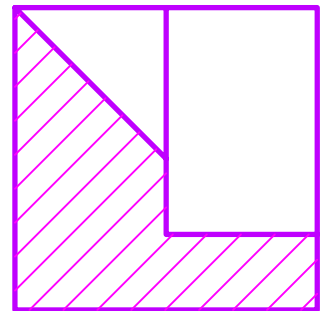

Aufriss

Schnitt mit Ebene $y = 1$

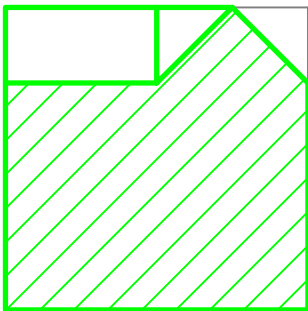

Kreuzriss
(A. v. rechts)

Schnitt mit Ebene $y = 2$

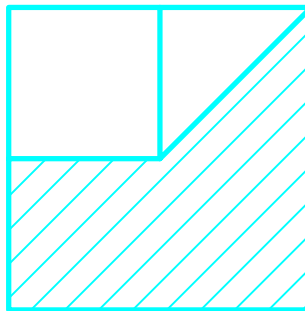

Kreuzriss
(A. v. rechts)

Schnitt mit Ebene $y = 3$

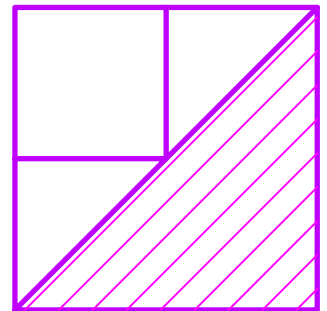

Kreuzriss
(A. v. rechts)

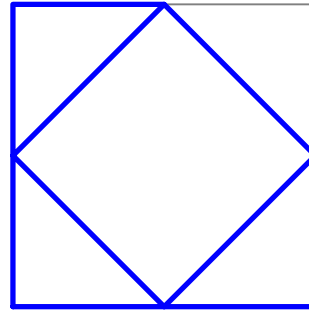
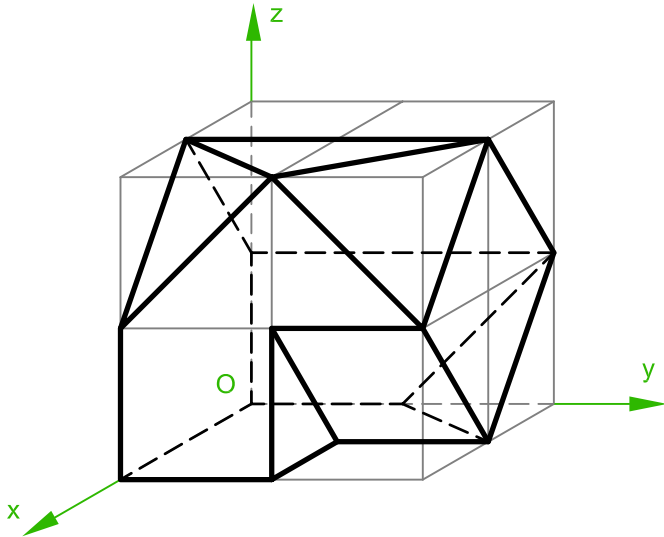

Kreuzriss
(A. v. rechts)

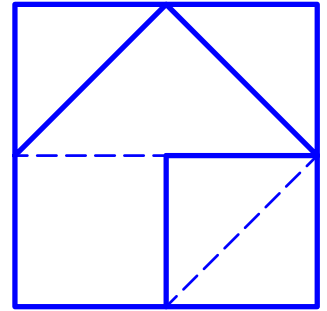

Aufriss

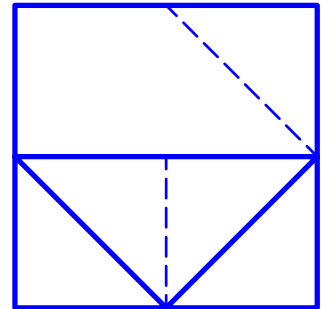

Grundriss

Schnitt mit Ebene $z = 1$

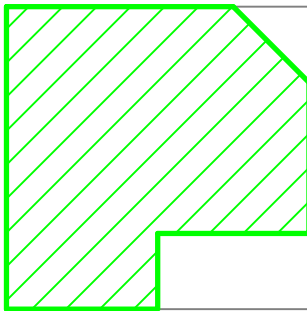

Grundriss

Schnitt mit Ebene $z = 2$

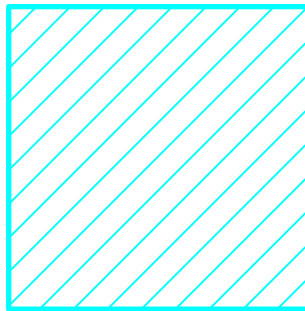

Grundriss

Schnitt mit Ebene $z = 3$

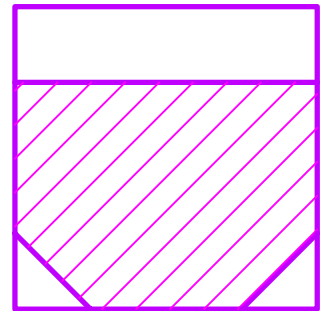

Grundriss

Schnitt mit Ebene $x = 1$

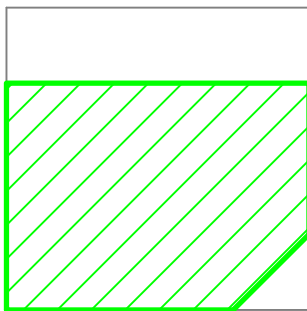

Aufriss

Schnitt mit Ebene $x = 2$

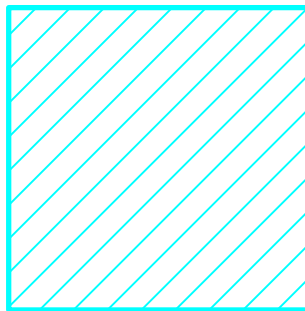

Aufriss

Schnitt mit Ebene $x = 3$

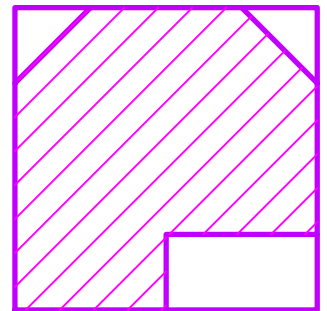

Aufriss

Schnitt mit Ebene $y = 1$

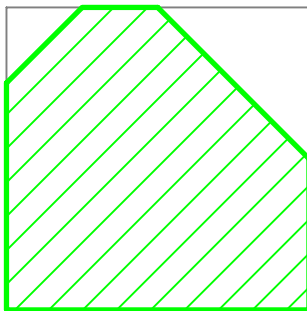

Kreuzriss
(A. v. rechts)

Schnitt mit Ebene $y = 2$

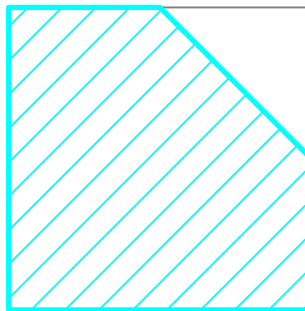

Kreuzriss
(A. v. rechts)

Schnitt mit Ebene $y = 3$

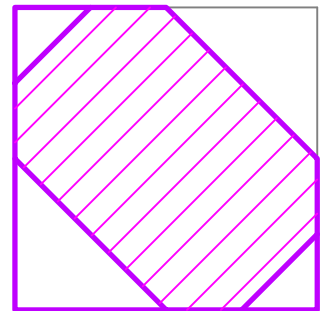

Kreuzriss
(A. v. rechts)